

IEC60309 32A

VIEW A

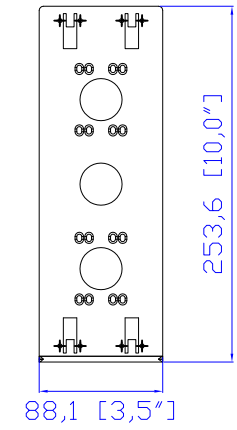
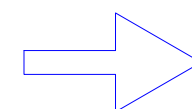
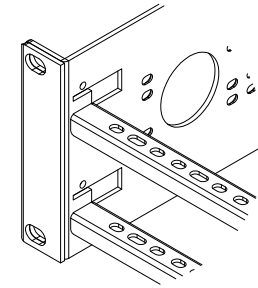
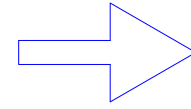
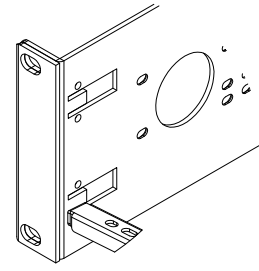
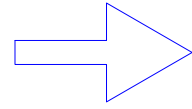
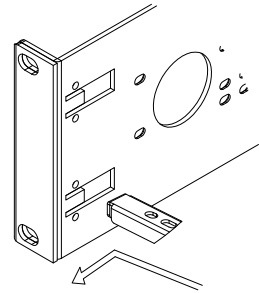

VIEW B

Rear

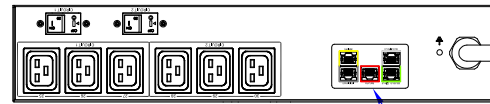

See VIEW C

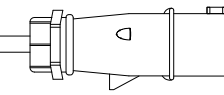

See VIEW A

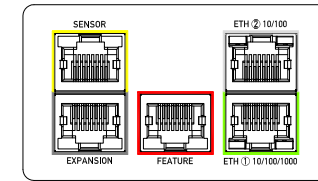

VIEW C

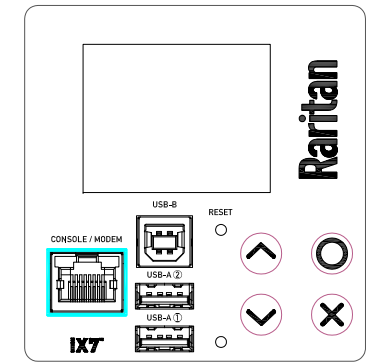

VIEW D

TOP

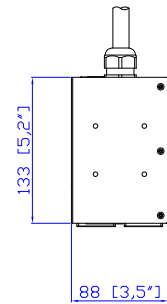
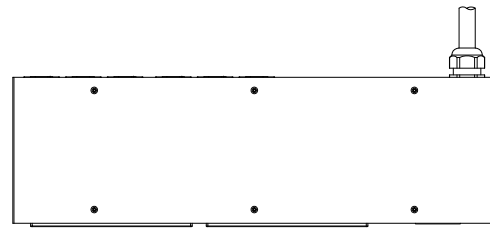

Front

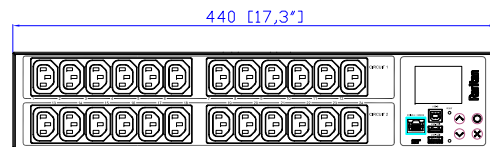

See VIEW D

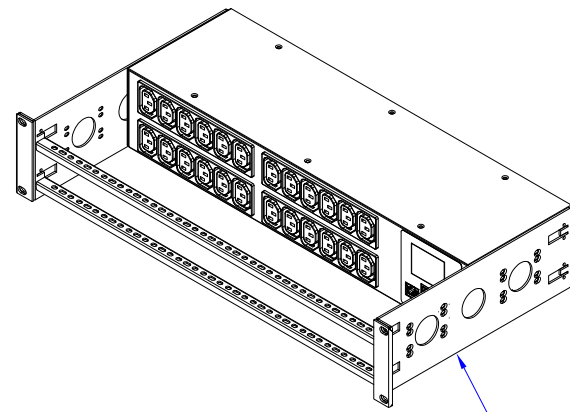

See VIEW B

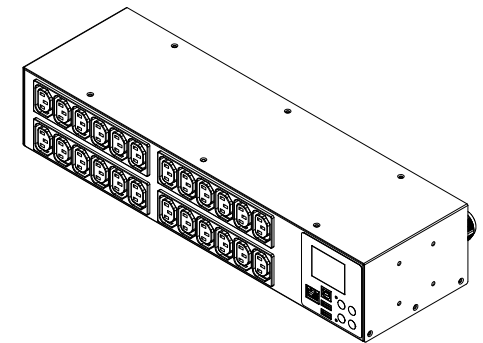

NOTES:

1. INSTALLATION SHALL COMPLY WITH ALL APPLICABLE NATIONAL, STATE AND LOCAL CODES.
2. PLEASE REFER TO PRODUCT DOCUMENTATION FOR FURTHER INFORMATION.
3. UNLESS OTHERWISE SPECIFIED, ALL DIMENSIONS ARE IN MILLIMETERS (INCHES).
4. MOUNTING BUTTON IS AN ALTERNATIVE MOUNTING METHOD TO THE TOOLLESS MOUNT FOR 3RD PARTY ENCLOSURE. BUTTON IS PROVIDED WITH THE UNIT. DETAILED INSTALLATION INSTRUCTIONS CAN BE FOUND IN THE PROVIDED MANUAL.
5. BRACKET KITS TO MOUNT TO SPECIFIC 3RD PARTY ENCLOSURES ARE AVAILABLE AS OPTIONS.
6. LENGTH OF THE CORD IS 3000MM +/- 70MM
7. DIMENSION TOLERANCE: LENGTH +/- 3MM, WIDTH +/- 1MM, DEPTH +/- 0.5MM
8. REFER TO THE TABLE FOR DETAIL CORD LENGTH DEFINITION

**Raritan**  
A brand of **legrand**



PROJECTION  
THIRD ANGLE

DO NOT SCALE DRAWING

SHEET 1 OF 1

THIS DRAWING AND SPECIFICATIONS HEREIN ARE THE PROPERTY OF RARITAN, Inc. AND SHALL NOT BE COPIED, REPRODUCED OR USED, IN WHOLE OR IN PART, AS THE BASIS FOR THE MANUFACTURE OR SALE OF ITEMS WITHOUT WRITTEN PERMISSION FROM RARITAN, Inc. THIS DRAWING IS BASED UPON LATEST AVAILABLE INFORMATION AND IS SUBJECT TO CHANGE WITHOUT NOTICE.

Drawing Maker:	Eva_Lin	Aug. 11, 2017
Design Engineer:	Sam_L	Aug. 11, 2017
Approver:	Tom_H	Aug. 11, 2017

TITLE: iPDU Two U  
Single Phase, 32A/200-240V  
Plug Type: IEC60309 32A  
Outlet Type: C13 (24), C19 (6)

DWG NO. MPX3-1842R M5

MODEL NO. PX3-1842R & PX3-1842R-M5

REV. 2A