

DS-1271ZJ-110

Pendent Mounting Bracket for Mini Dome Camera

Features:

- Aluminum alloy material with surface spray treatment
- Indoor/Outdoor general design
- Internal routed cable design
- Cable entrance is reserved for convenient wiring indoor
- Better water proof design

Dimension:

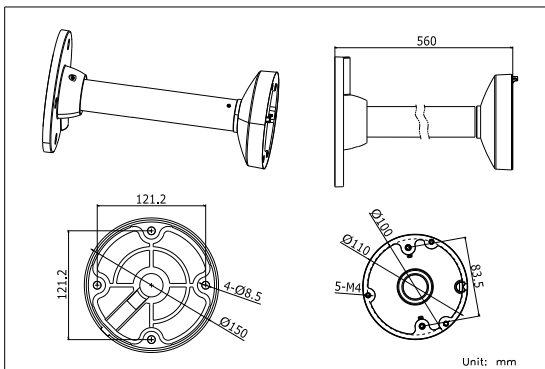

Model Suitable:

DS-2CC51D3S-VPIR, DS-2CD2112-(I), DS-2CD2132-(I)

Installation Step:

- ① Choose the appropriate wall to install the ceiling plate and thread the cable
- ② Connect pole and adapter; thread cable and screw up
- ③ Screw up and complete the fixation of adapter and pole
- ④ Take off lower dome, inner module and lining

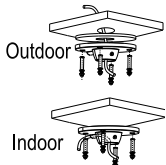

Waterproof rubber is necessary for outdoor application

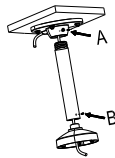

A&B: Tightening Screw

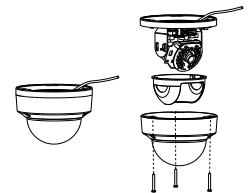
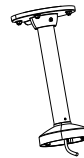

- ⑤ Thread the cable and fix inner module to adaptor
- ⑥ Adjust the view angle of camera
- ⑦ Install lining and lower dome alternatively to inner module and fix them
- ⑧ Installation complete.

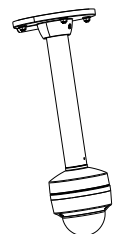
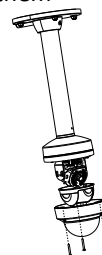
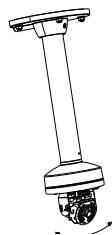
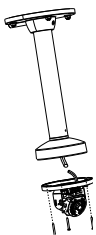

Order Model:

DS-1271ZJ-110

Parameter:

Model	DS-1271ZJ-110
Parameters	Pendent Mounting Bracket for Dome Camera
Appearance	Hikvision White
Range of Application	Suitable for dome camera pendent mounting
Material	Aluminum Alloy
Dimension	Φ 150×560mm
Weight	1270g

Notice:

- The bracket should be installed on flat wall
- Waterproof rubber is necessary for outdoor application
- The wall must be capable of supporting over 3 times as much as the total weight of the camera and the mount.
- The maximum load capacity of the bracket is 4.5KG



Note: The figure of Speed Dome in "Installation Step" is only for your reference; please adhere to our real products.